

# ANTIBES DINING CHAIR

PLEASE KEEP THE ORIGINAL PACKAGING UNTIL THE ITEM IS FULLY ASSEMBLED AND IN PLACE. IN THE UNLIKELY EVENT THAT YOU NEED TO RETURN YOUR PRODUCT, IT MUST BE RETURNED IN ITS ORIGINAL PACKAGING TO AVOID FURTHER DAMAGE .

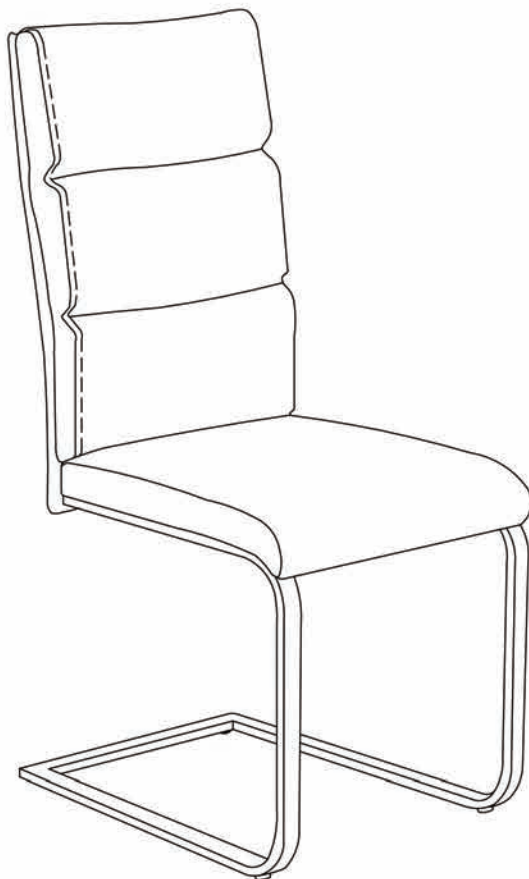

**PLEASE READ** this sheet prior to assembly to familiarise yourself with the various stages of construction.

Carefully open the pack supplied and check the contents against the parts and fittings check list.

Do not destroy any of the packaging until you are certain that you have all the necessary parts for the assembly.

Please ensure that the packaging is disposed off in a safe environmentally friendly way.

**CAUTION:** There are small components used in the construction of this unit. These loose items should be kept away from young children whilst assembling your unit to avoid the danger of choking hazards.



1 Person Build

# ANTIBES DINING CHAIR

## **Important: Read carefully and retain for future reference.**

- The product you have chosen will give you many years of service if you follow the guidelines below for safe assembly, periodic maintenance and cleaning.
- Please check you have all parts listed on your assembly sheet. In the unlikely event that any parts are missing, please contact your retailer immediately. Ensure that this product is fully assembled as illustrated before use.
- Check all screws or bolts are tightened and inspect regularly.
- Do not use any other tools than those listed on your assembly sheet / tools provided. Use of power tools could damage your product and returns would not be accepted back in these circumstances. Use of power tools could also make your product unsafe due to overtightening.
- Please keep the original packing until your item is fully assembled and in place. In the unlikely event you need to return your product, it must be returned back in its original packing to avoid any damage.
- Depending on the amount of use your product receives, it may be necessary to tighten the fixings from time to time. This is completely normal for flatpack furniture.
- For cleaning please use a clean damp cloth or duster. Use of abrasive or chemical cleaners will most likely scratch or damage the surface of your product. We do not accept returns for damages arising from incorrect care of products.
- The surface of this item is not heat resistant. Please use a mat under hot, cold or wet items to prevent marking.
- Please ensure all legs are level on your floor before fully tightening the screws. All chairs have some variance in the assembly process to allow for unevenness in the majority of domestic home floors.

## **WARNINGS.**

- This product should only be used on firm level ground.
- Keep small parts out of reach of children.
- This product has been designed for use by one person at a time.
- Do not use power tools to construct this product.
- Do not tighten screws until fully assembled.
- Do not over tighten screws or bolts.

## **CARE INFORMATION.**



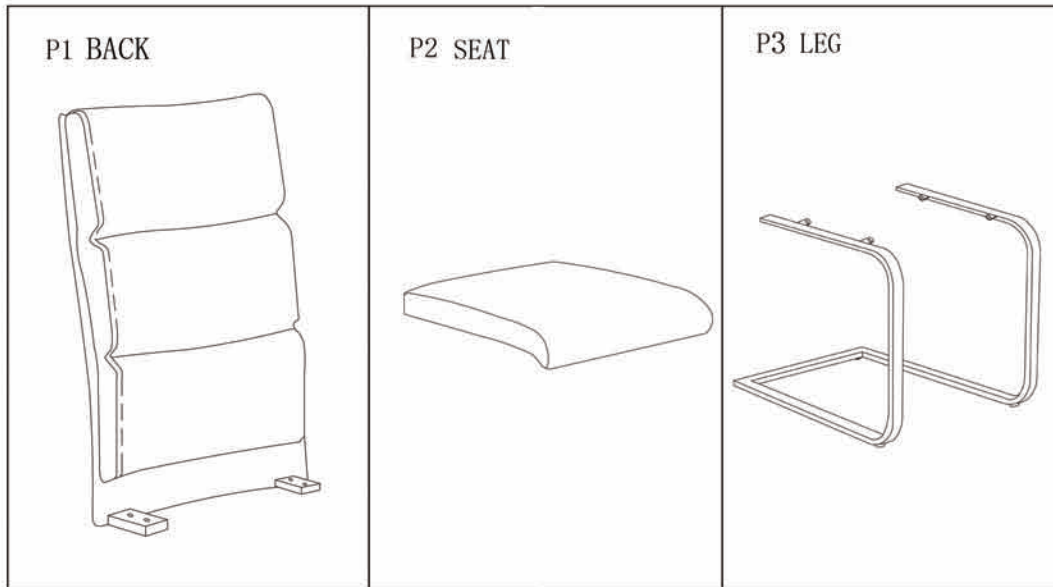

- Never use scourers, abrasives or chemical cleaners.
- To clean and wipe with damp cloth. Do not use solvent based cleaners or detergents as they can bleach or damage the product.

# ANTIBES DINING CHAIR

## Parts Identification



## Fittings Identification

Code	Description	Image	Quantity
A	M6x13mm SCREW		4 PCS
B	M6x16mm SCREW		4 PCS
C	M6x16mm WASHER		8 PCS
D	ALLEN KEY		1 PC

# ANTIBES DINING CHAIR

## STEP 1

### PARTS REQUIRED

P1x1

P3X1

Ax4

Cx4

Dx1

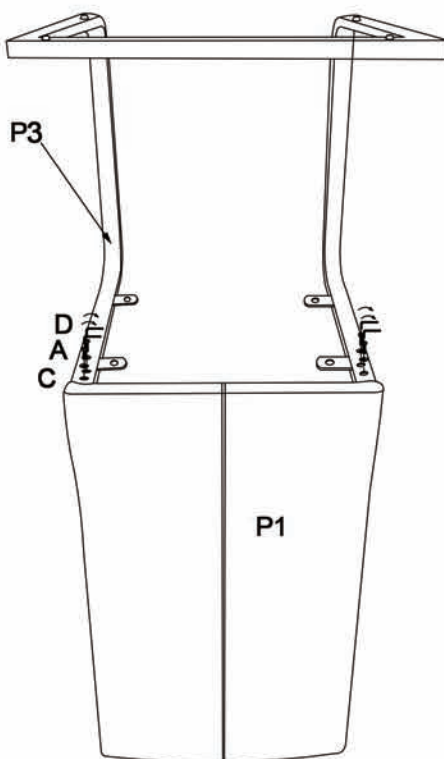

## STEP 2

### PARTS REQUIRED

P2x1

Bx4

Cx4

Dx1

