

WHITE TOLEDO 5 DRAWER NARROW CHEST ASSEMBLY INSTRUCTIONS

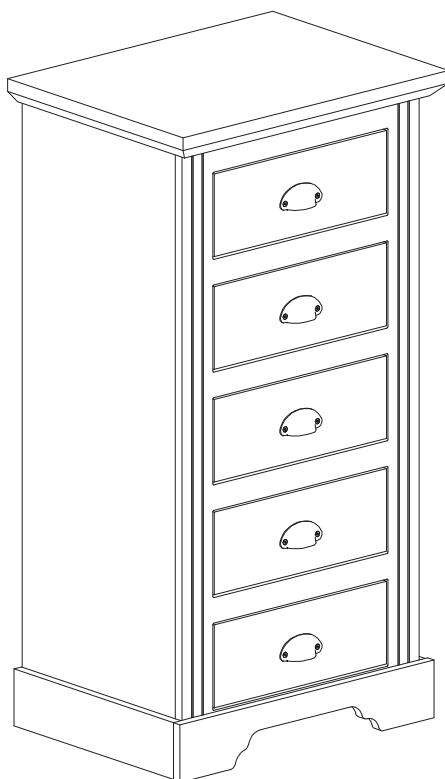

**IMPORTANT
FOR DOMESTIC USE ONLY
PLEASE READ BEFORE YOU CONTINUE FURTHER**

CARE AND MAINTENANCE

- After unpacking this product please keep the original packaging in case it needs to be returned for any reason.
- Please ensure all fittings and parts are present before commencing with assembly.
 - Never drag or push products as this could cause damage to the joints making it inferior.
 - We strongly recommend that you keep children away from your work area.
 - We recommend that you lay a blanket or sheet on the floor to avoid damage to both your floor and the product.
 - Assemble this product as close to its final position as possible.
 - Do not place this product next to a radiator or in direct sunlight.
 - Do not drag or push items across your high gloss furniture as this may cause the surface to scratch
 - Wood is a natural product and may expand if subjected to damp and may shrink or crack if subjected to heat. Therefore it is recommended that room temperature is maintained, with no sudden temperature fluctuations.
 - Make sure any spillage is wiped off immediately.
 - Do not place hot or chilled items directly on to the surface, use a place mat or marking will occur.
 - For general cleaning use a soft cotton or micro fibre cloth, and do not use detergents of any kind.
 - From time to time it may be necessary to tighten fittings, regular inspections should be carried out.
 - Do not place on a wet or damp floor as staining may occur to your floor.

TOOLS REQUIRED

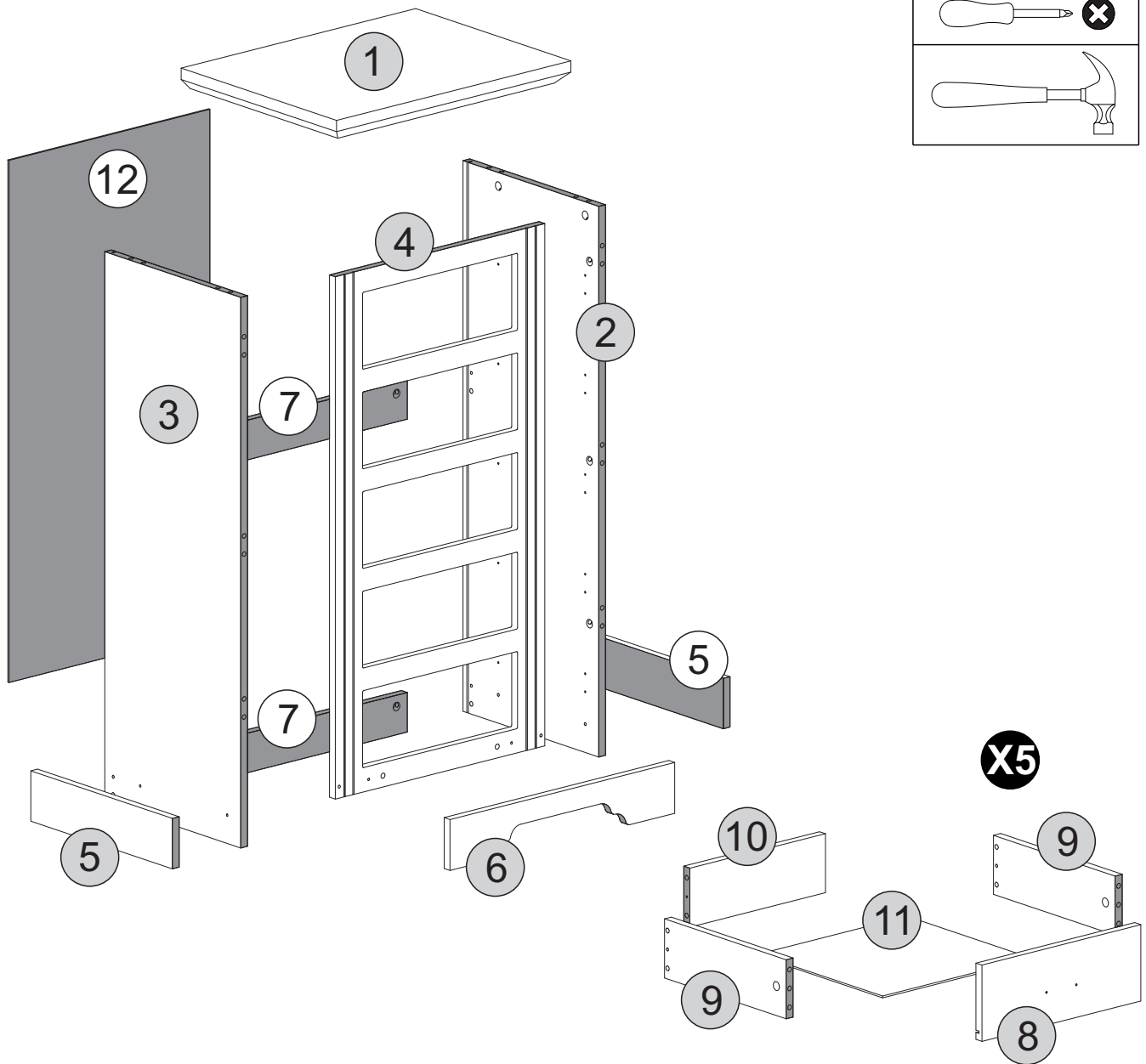
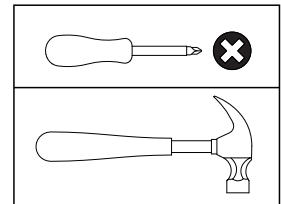













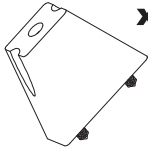
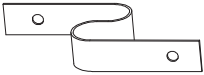



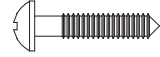
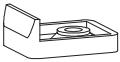

Please Note:

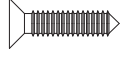
The below parts have been stamped with the part number to help identify them during assembly.

Part Number	Part Code	Part Description	Quantity	Carton
1	S100-102-143-HV1-01	Top Panel	1	1/1
2	S100-102-143-HV1-02	Right Side Panel	1	1/1
3	S100-102-143-HV1-03	Left Side Panel	1	1/1
4	S100-102-143-HV1-04	Front Frame	1	1/1
5	S100-102-143-HV1-05	Side Plinth	2	1/1
6	S100-102-143-HV1-06	Front Plinth	1	1/1
7	S100-102-143-HV1-07	Back Baseboard	2	1/1
8	S100-102-143-HV1-08	Drawer Front	5	1/1
9	S100-102-143-HV1-09	Drawer Side	10	1/1
10	S100-102-143-HV1-10	Drawer Back	5	1/1
11	S100-102-143-HV1-11	Drawer Bottom	5	1/1
12	S100-102-143-HV1-12	Back Panel	1	1/1

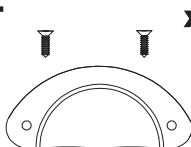
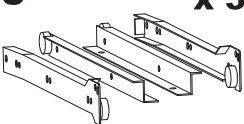
FITTINGS LIST

A x 24  +/2 Cam Bolt 32xØ6mm	B x 24  +/2 Can Nut Ø15 mm	C x 56  +/2 Dowel Ø8 x 30 mm	D x 2  +/1 Washer Ø16x7mm	E x 20  Drawer Spacer 52x45x22 mm
F x 1  Strap 200x20x1 mm	G x 20  +/2 Screw Ø4 x 14 mm	H x 10  +/2 Screw Ø4 x 40 mm	I x 3  +/1 Screw Ø3.5 x 14 mm	J x 6  +/1 Screw Ø4 x 25 mm
K x 4  +/1 Plastic Foot L 19x17x8mm Ø2mm	L x 29  +/2 Nail 10x10 Ringed 1,5x23 mm	M x 2  Glue 10g	N x 10  +/2 Hole Plugs 19mm	O x 40  +/2 Screw Ø4 x 22 mm
P x 20  +/2 Screw Ø3 x 20 mm	Q x 14  +/2 Screw Ø3 x 16 mm	R x 1  +/1 Screw Ø3.5 x 30 mm	S x 14  +/2 Triangle Support Angle	T x 5  Handle
U x 5  Normal Slide 300mm	V x 2  +/1 Screw Ø3.5 x 40 mm			

TIPS FOR FITTINGS CAM-LOCKS

WHEN FITTING CAM NUT, ENSURE STARTING POSITION IS CORRECT BEFORE YOU INSERT. CONNECTING CAM BOLT TURN CLOCKWISE UNTIL SECURE



↑
CORRECT



↑
WRONG

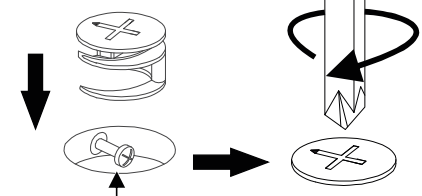

Cam bolt head needs to be in centre

CAMBOLT
Tighten until shoulder in flush with panel. Do not overtighten or undertighten (see example beside)

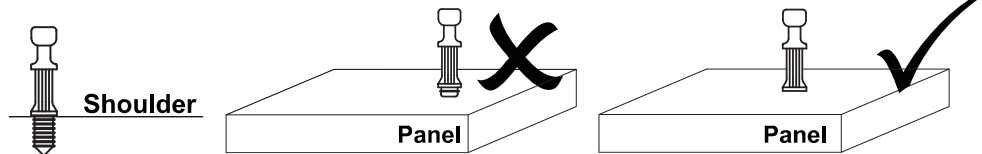

STEP 1

PARTS REQUIRED

2 - RIGHT SIDE PANEL x1

HARDWARE REQUIRED

C  05

K  02

L  02

M  01

TOOLS REQUIRED

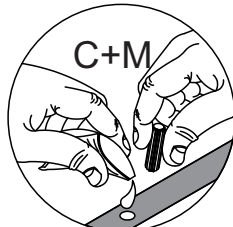
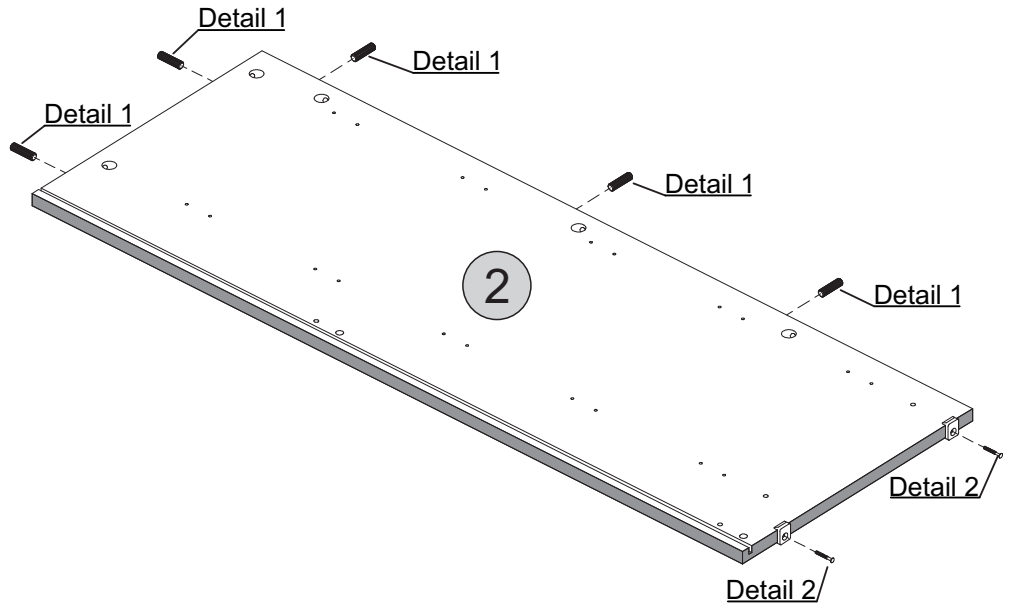
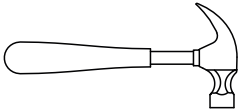

Detail 1

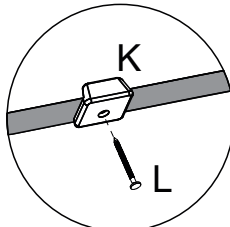

Detail 2

STEP 2

PARTS REQUIRED

2 - RIGHT SIDE PANEL x1

HARDWARE REQUIRED

A  02

E  10

O  20

TOOLS REQUIRED

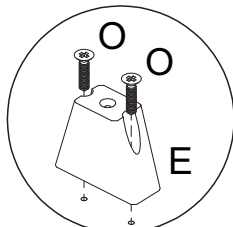
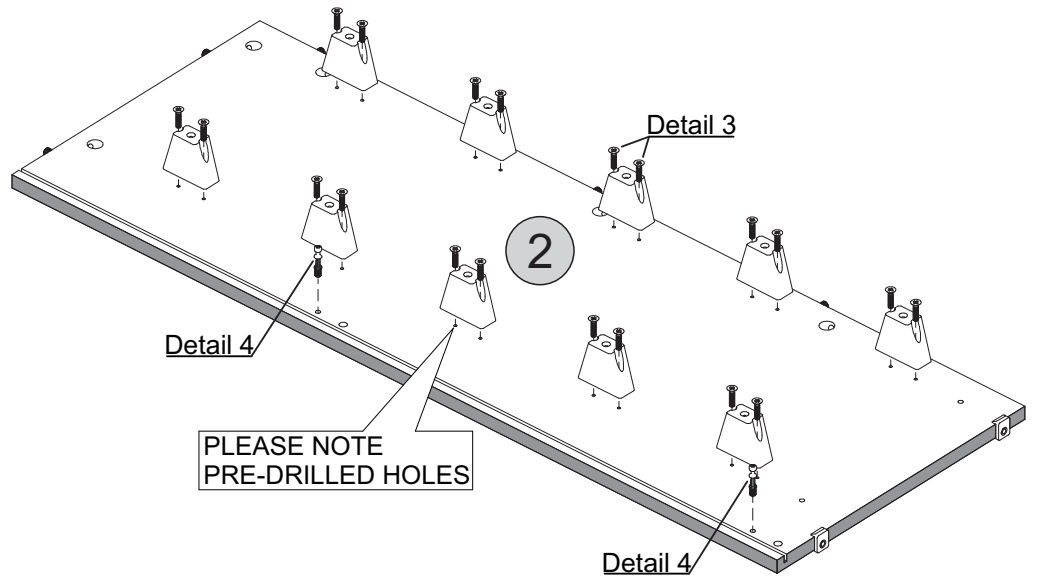
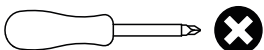

Detail 3

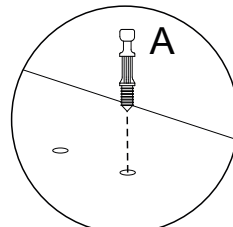

Detail 4

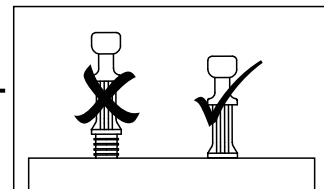

STEP 3

PARTS REQUIRED

2 - RIGHT SIDE PANEL x1

HARDWARE REQUIRED

G  10

U  RIGHT 05

TOOLS REQUIRED

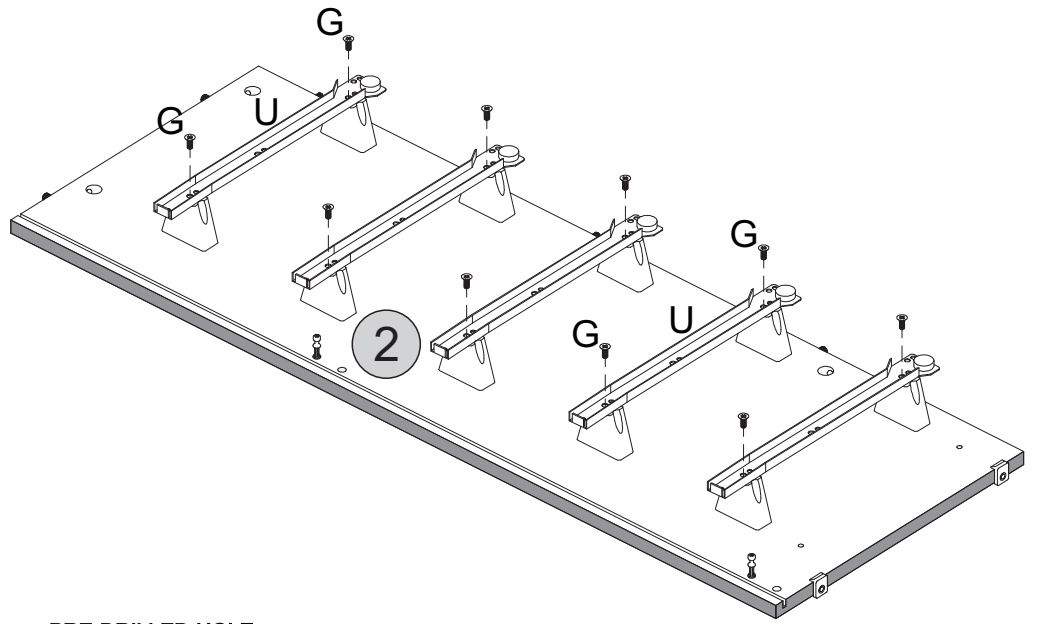
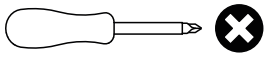

PRE-DRILLED HOLE

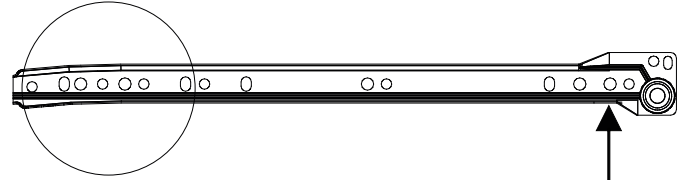

SECOND HOLE (LINE UP WITH PRE-DRILLED HOLE)

STEP 4

PARTS REQUIRED

3 - LEFT SIDE PANEL x1

HARDWARE REQUIRED

C  05

K  02

L  02

M  01

TOOLS REQUIRED

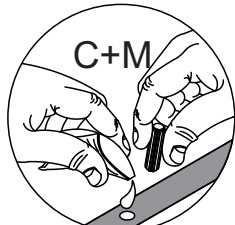
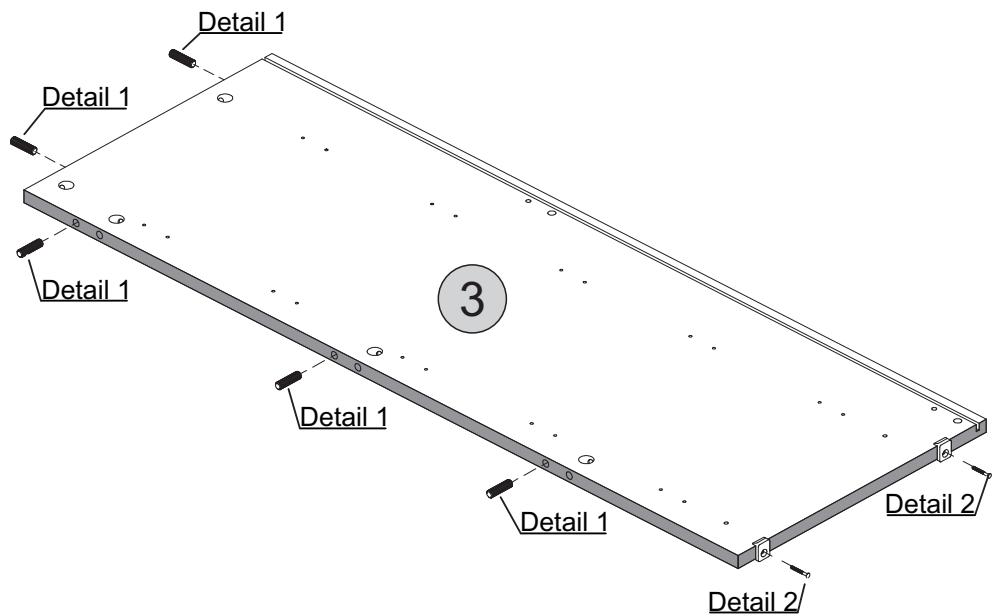
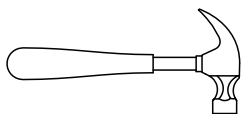

Detail 1

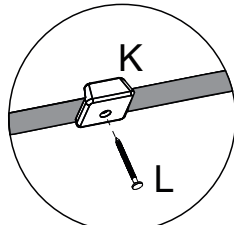

Detail 2

STEP 5

PARTS REQUIRED

3 - LEFT SIDE PANEL x1

HARDWARE REQUIRED

A  02

E  10

O  20

TOOLS REQUIRED

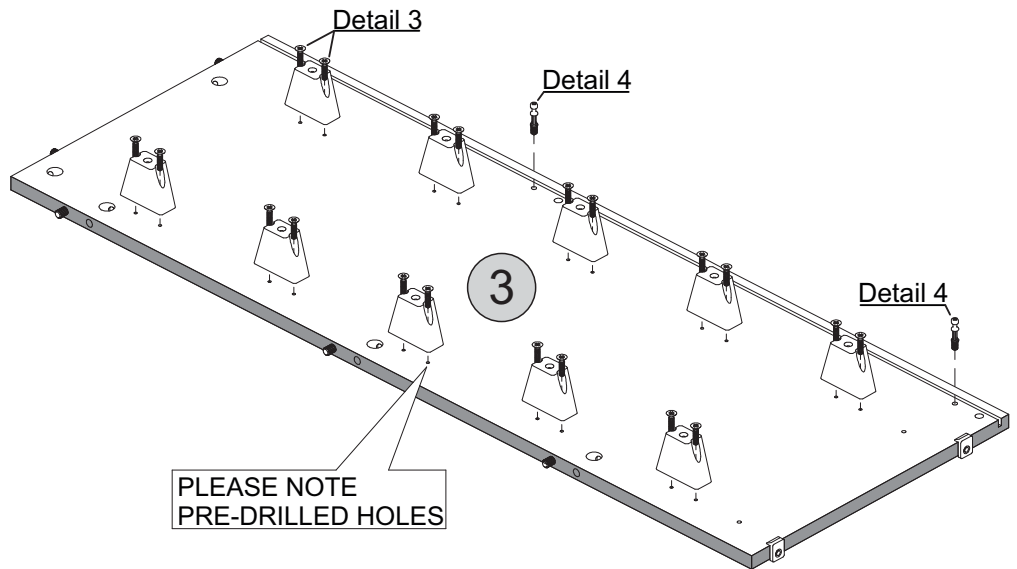

PLEASE NOTE
PRE-DRILLED HOLES

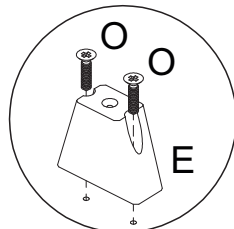

Detail 3

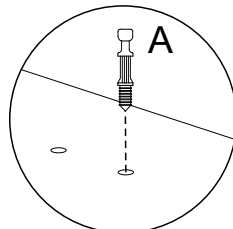

Detail 4

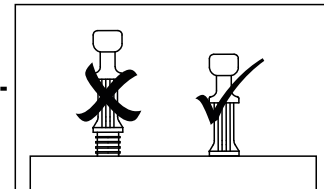

STEP 6

PARTS REQUIRED

3 - LEFT SIDE PANEL x1

HARDWARE REQUIRED

G  10

U  LEFT 05

TOOLS REQUIRED

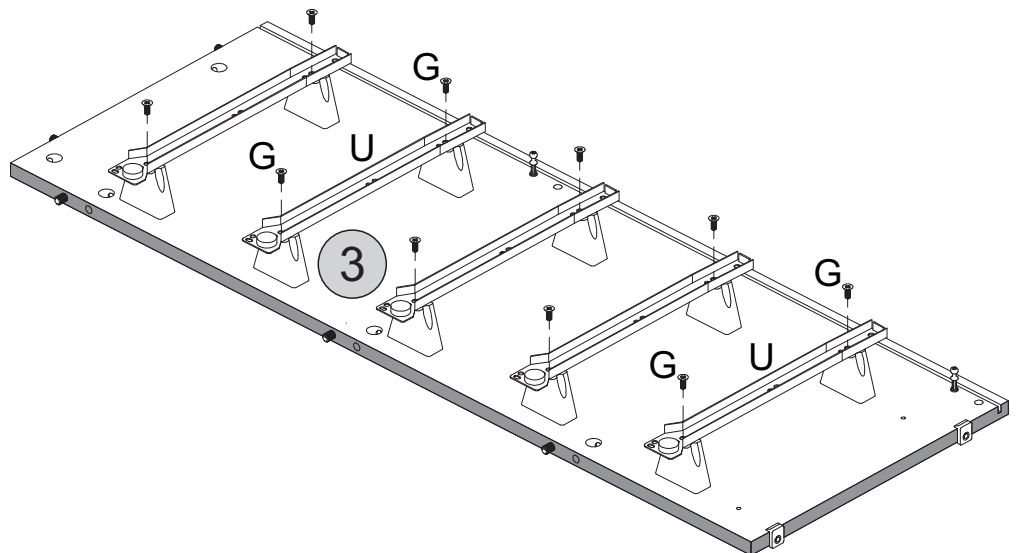
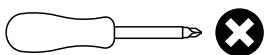

PRE-DRILLED HOLE

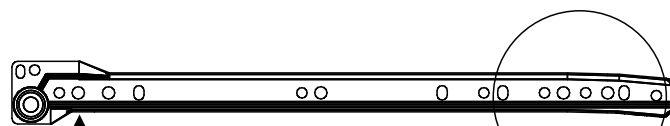

SECOND HOLE (LINE UP WITH PRE-DRILLED HOLE)

STEP 9

PARTS REQUIRED

2 - RIGHT SIDE PANEL x1

4 - FRONT FRAME x1

HARDWARE REQUIRED

B  03

TOOLS REQUIRED

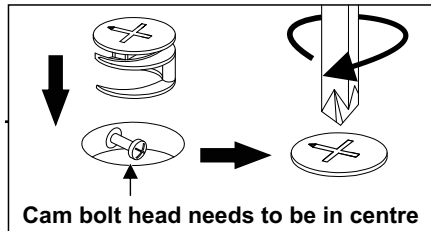
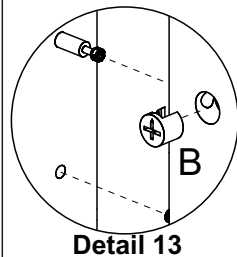
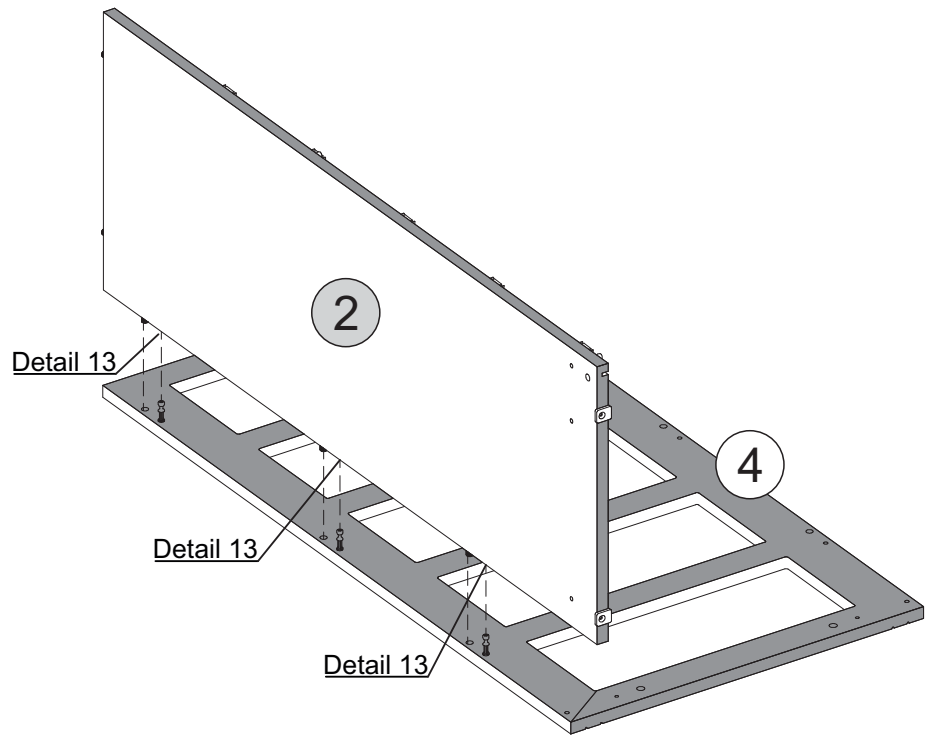
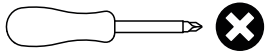

STEP 10

PARTS REQUIRED

3 - LEFT SIDE PANEL x2

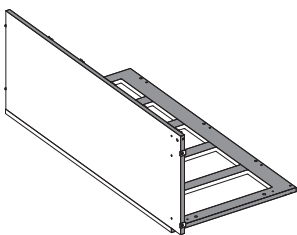

HARDWARE REQUIRED

B  03

TOOLS REQUIRED

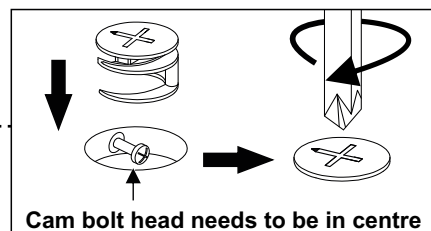
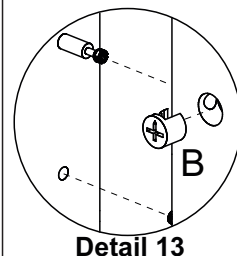
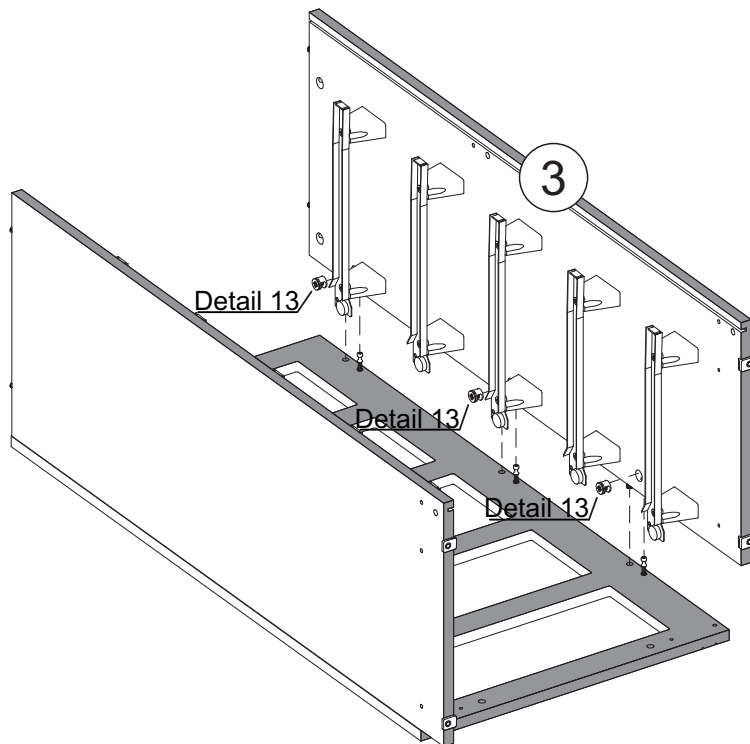
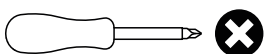

STEP 11

PARTS REQUIRED

7 - BACK BASEBOARD x2

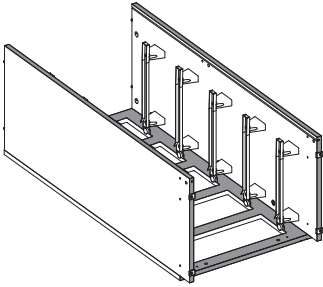

HARDWARE REQUIRED

B  04

TOOLS REQUIRED

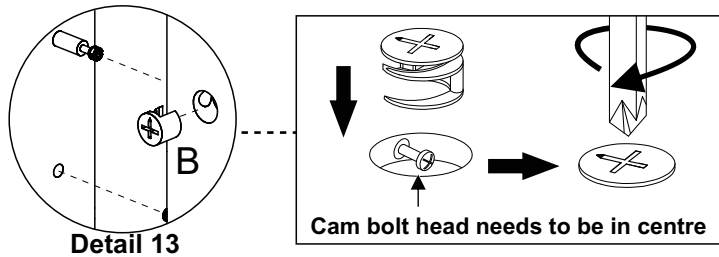
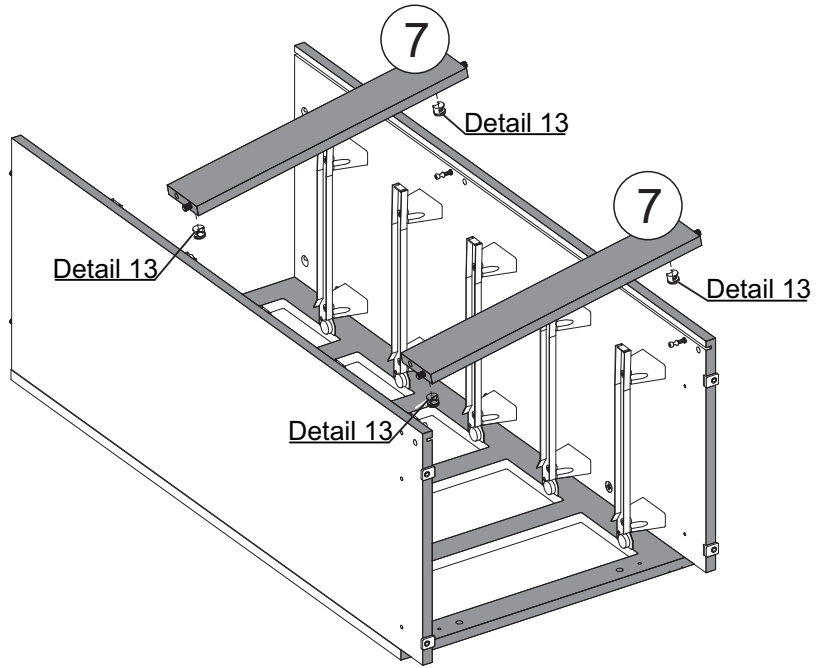
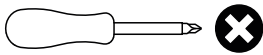

STEP 12

PARTS REQUIRED

1 - TOP PANEL x1

HARDWARE REQUIRED

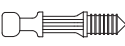
A  04

TOOLS REQUIRED

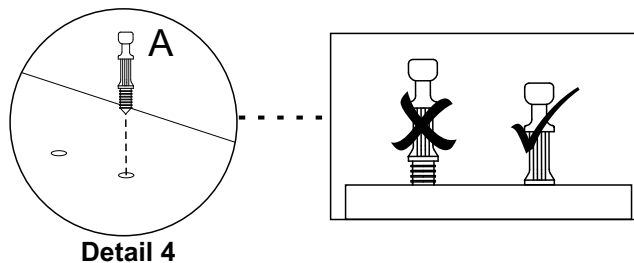
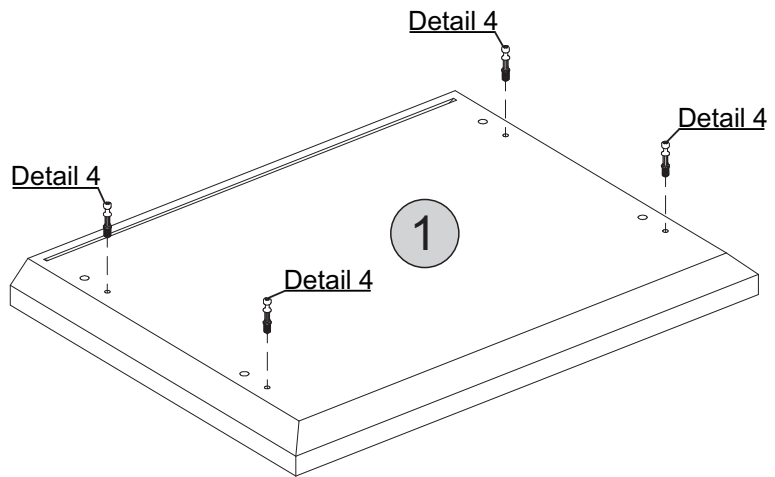
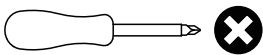

STEP 13

PARTS REQUIRED

1 - TOP PANEL x1

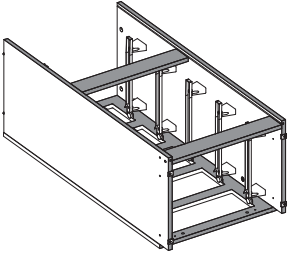

HARDWARE REQUIRED

B  04

TOOLS REQUIRED

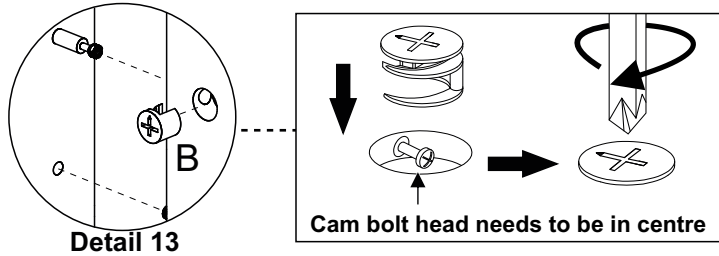
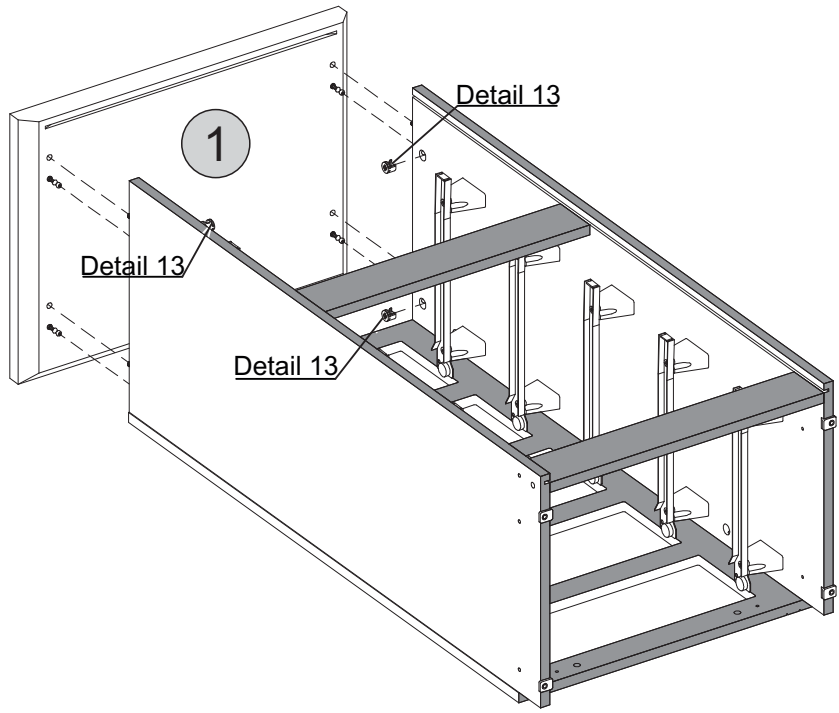
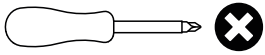

STEP 14

PARTS REQUIRED

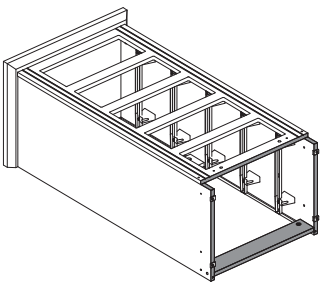

HARDWARE REQUIRED

V  02

TOOLS REQUIRED

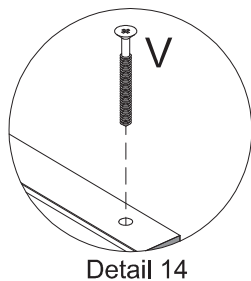
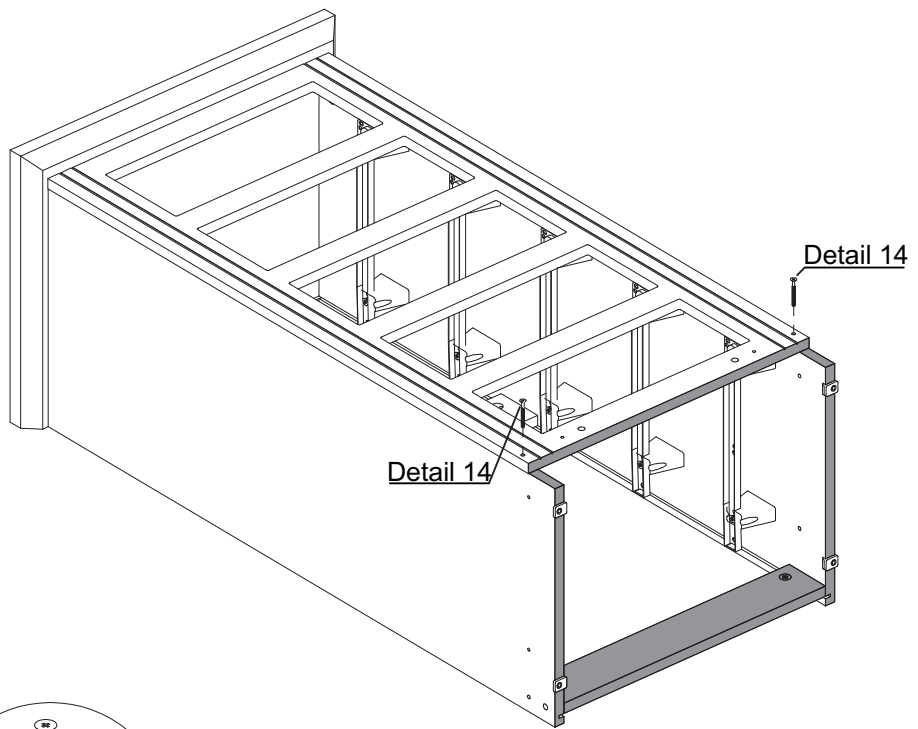
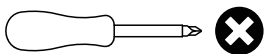

STEP 15

PARTS REQUIRED

- 5 - SIDE PLINTH x2
- 6 - FRONT PLINTH x1

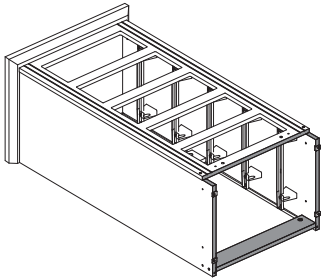

HARDWARE REQUIRED

- J  06

TOOLS REQUIRED

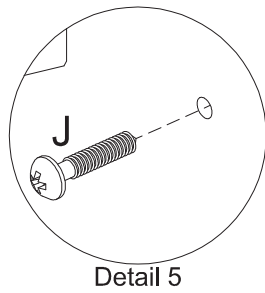
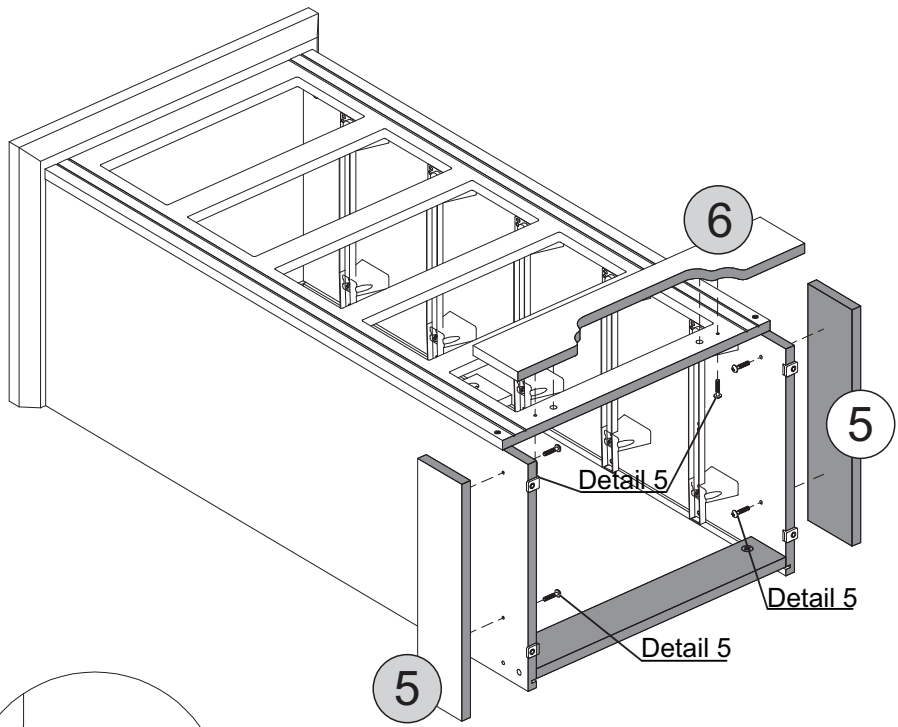
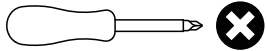

STEP 16

PARTS REQUIRED

- 12 - BACK PANEL x1

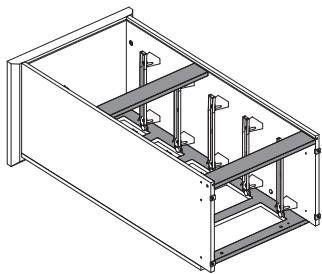

HARDWARE REQUIRED

TOOLS REQUIRED

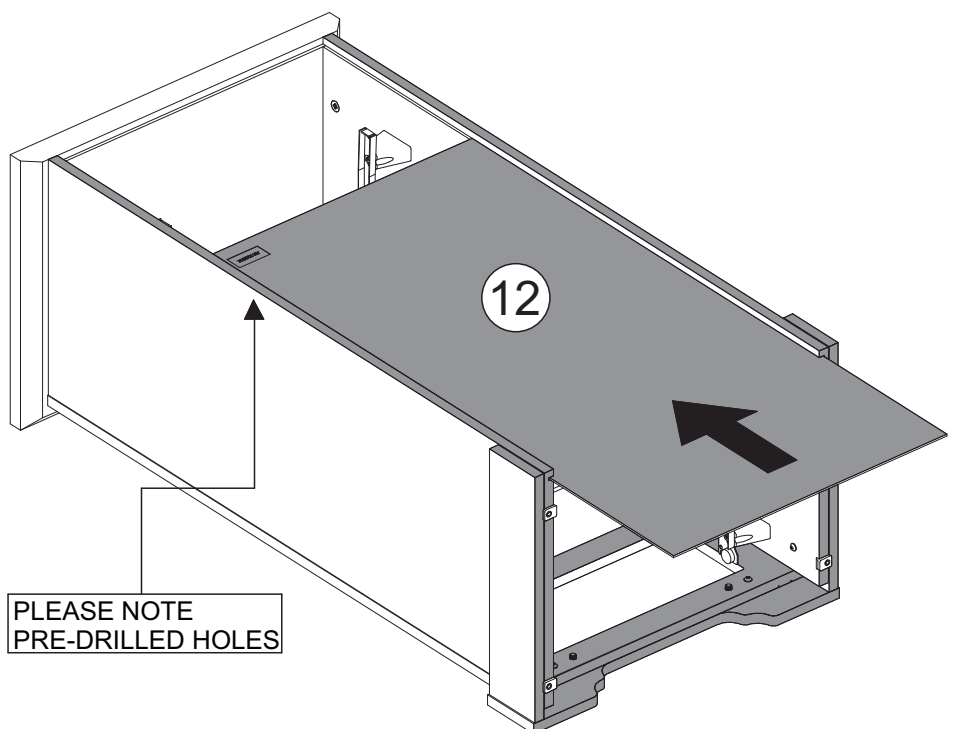
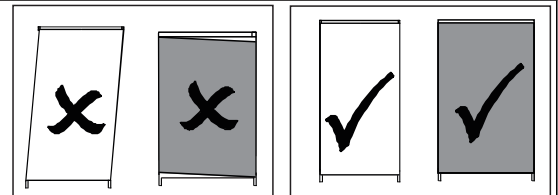

PLEASE NOTE
PRE-DRILLED HOLES

STEP 17

PARTS REQUIRED

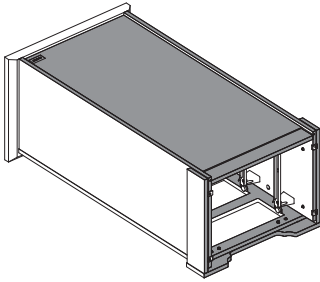

HARDWARE REQUIRED

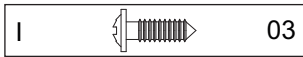

TOOLS REQUIRED

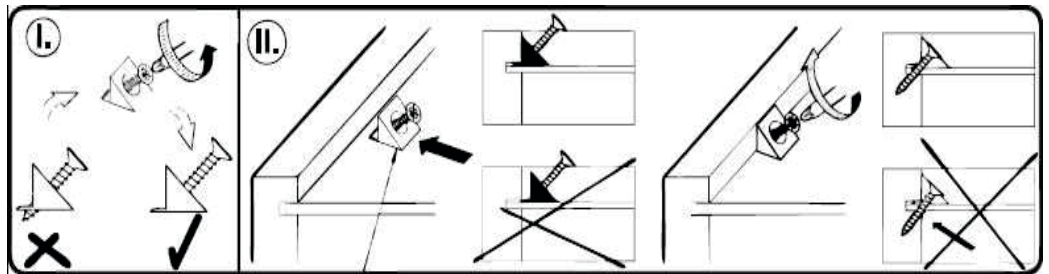
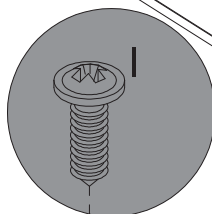
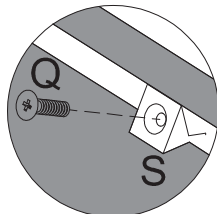
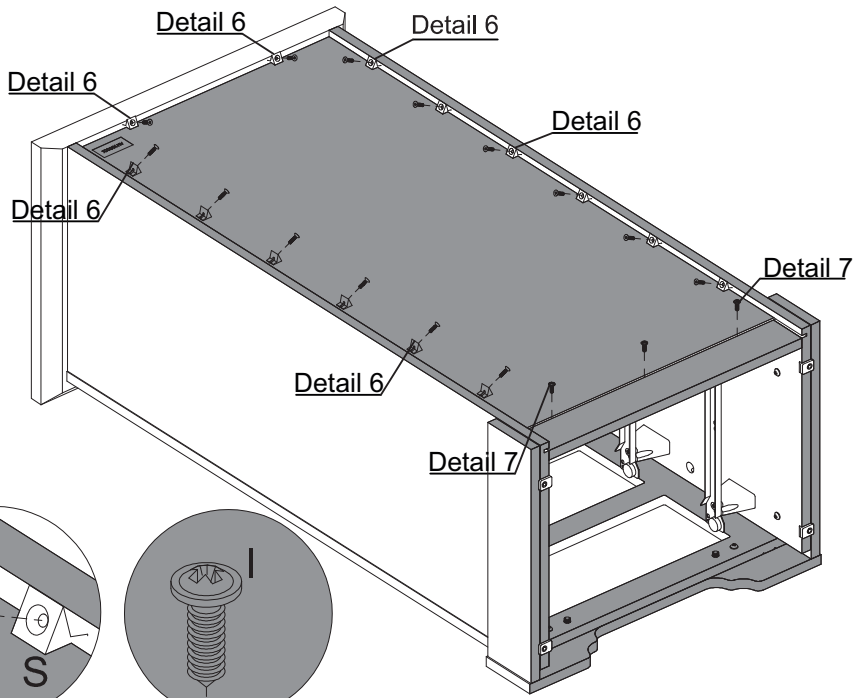
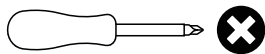

STEP 18

PARTS REQUIRED

9 - DRAWER SIDE	x10
-----------------	-----

10 - DRAWER BACK	x5
------------------	----

HARDWARE REQUIRED



TOOLS REQUIRED

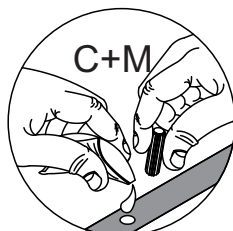
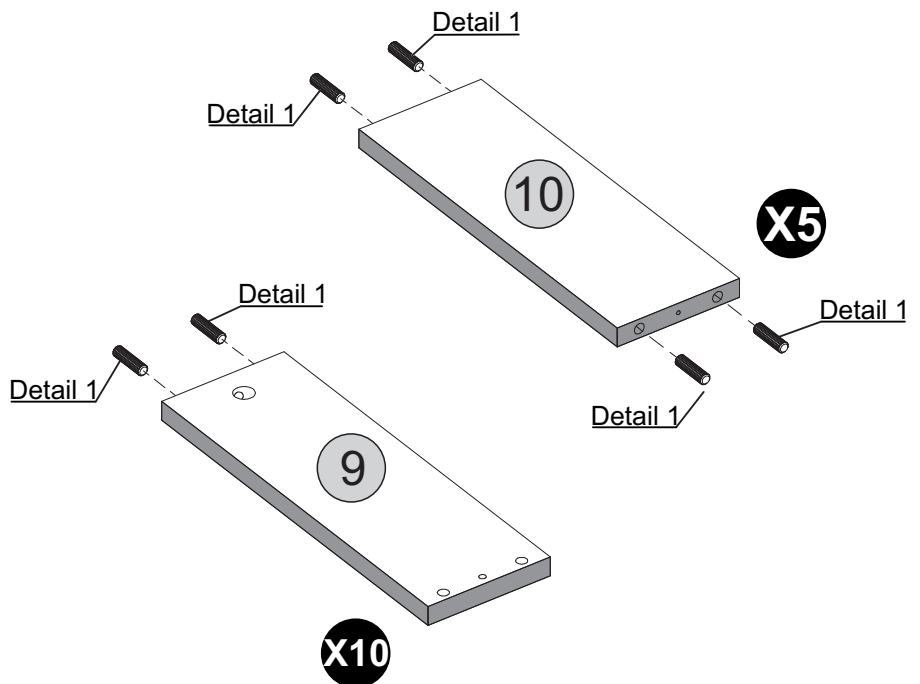
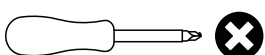

Detail 1

STEP 19

PARTS REQUIRED

8 - DRAWER FRONT x5

HARDWARE REQUIRED

A  10

TOOLS REQUIRED

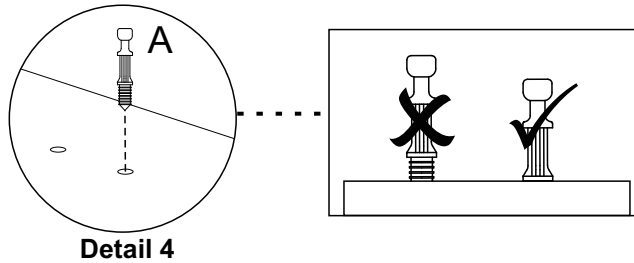
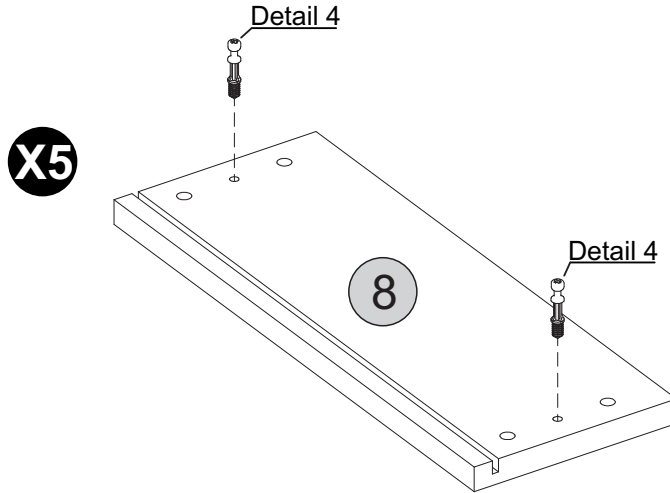
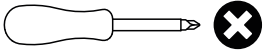

STEP 20

PARTS REQUIRED

9 - DRAWER SIDE x10

10 - DRAWER BACK x5

HARDWARE REQUIRED

H  10

TOOLS REQUIRED

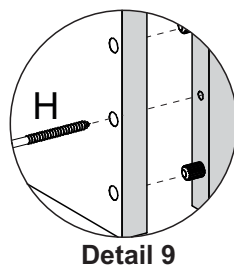
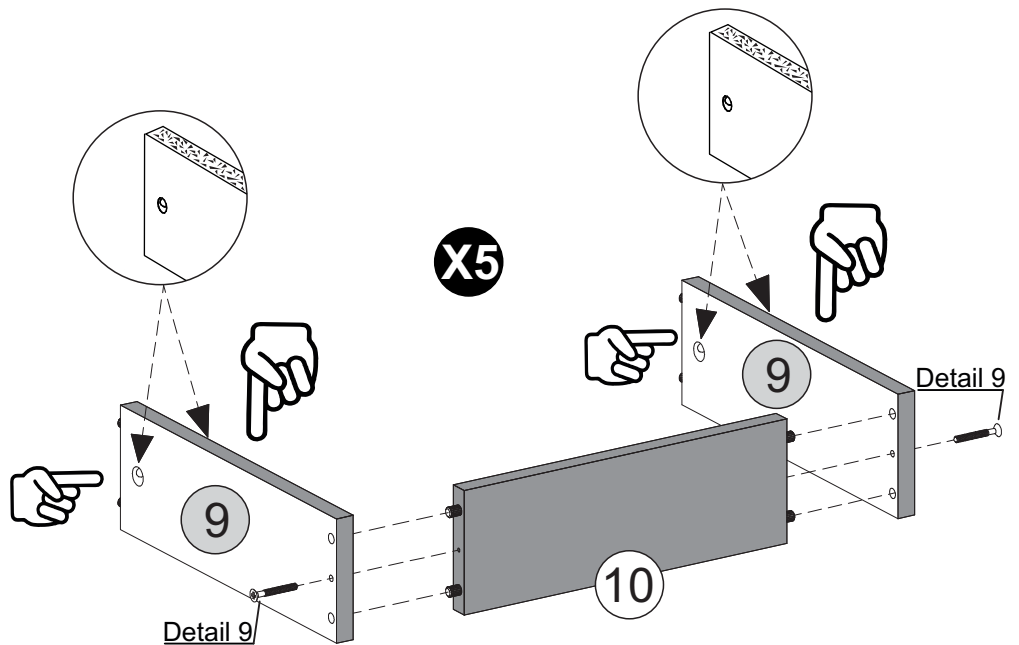
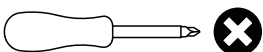

STEP 21

PARTS REQUIRED

8 - DRAWER FRONT x5

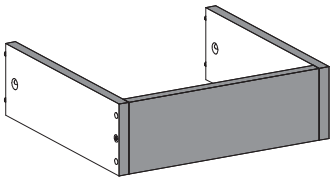

HARDWARE REQUIRED

B  10

TOOLS REQUIRED

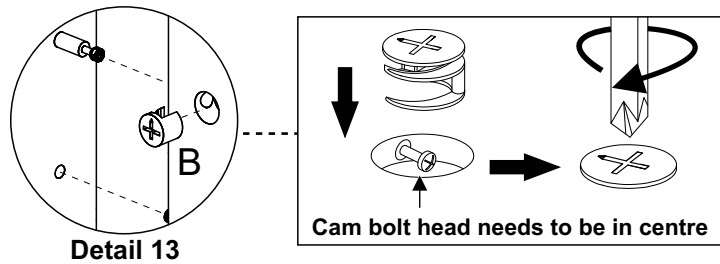
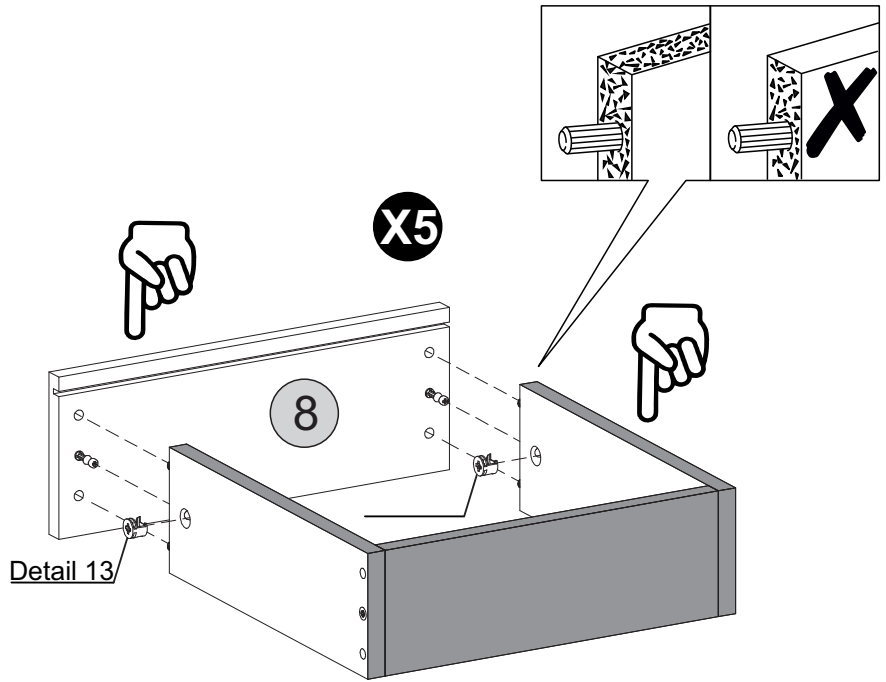

STEP 22

PARTS REQUIRED

11 - DRAWER BOTTOM x5

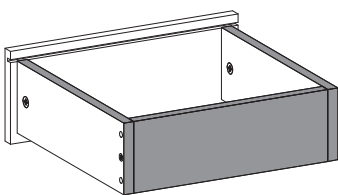

HARDWARE REQUIRED

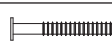
L  25

TOOLS REQUIRED

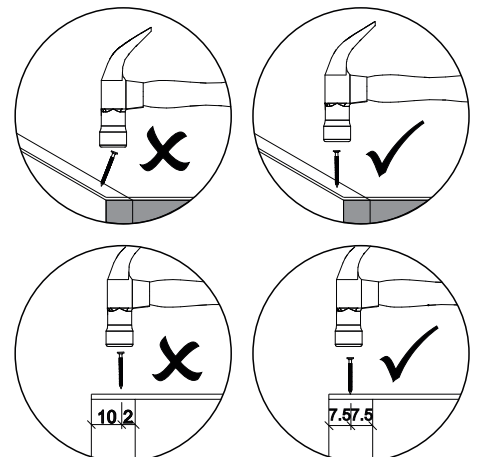
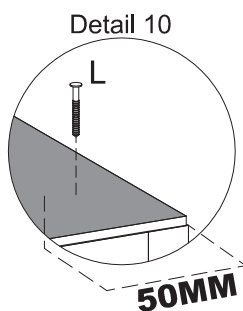
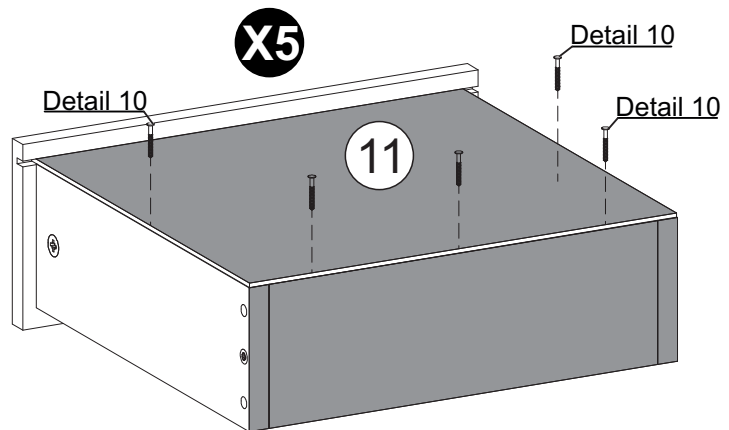
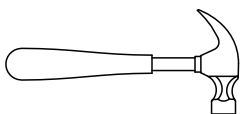

STEP 23

PARTS REQUIRED

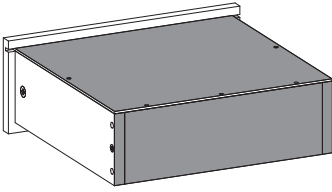

HARDWARE REQUIRED

P		20
U	 RIGHT LEFT	05

TOOLS REQUIRED

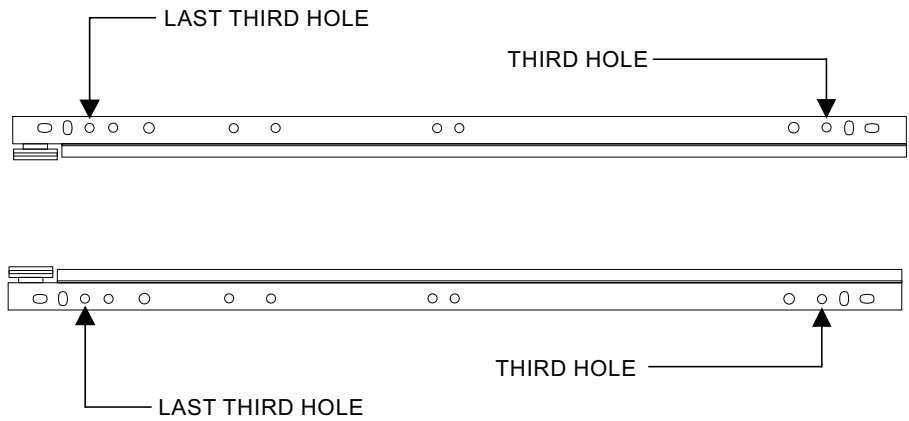
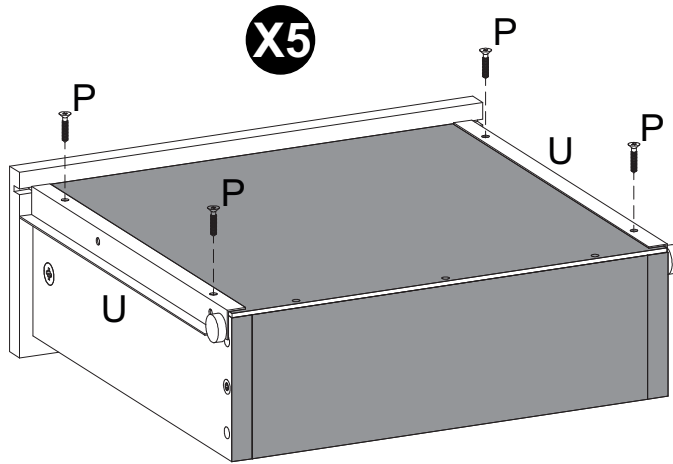
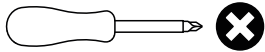

STEP 24

PARTS REQUIRED

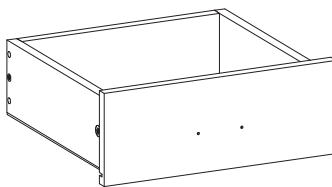

HARDWARE REQUIRED

N		10
T		05

TOOLS REQUIRED

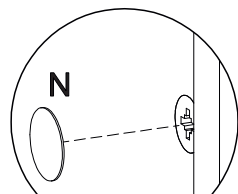
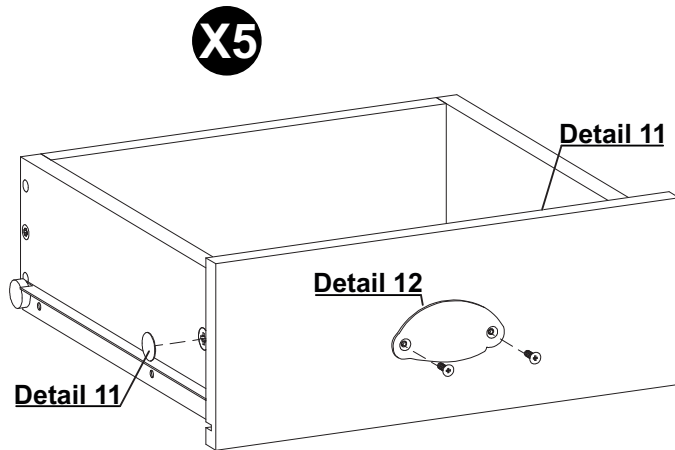
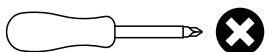

Detail 11

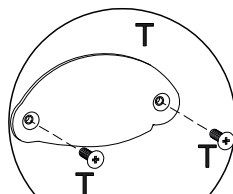

Detail 12

STEP 25

TIP
 If desired, after assembly use an alcohol cleaner to erase the number printed on the parts.



PARTS REQUIRED

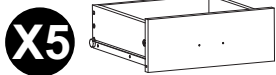
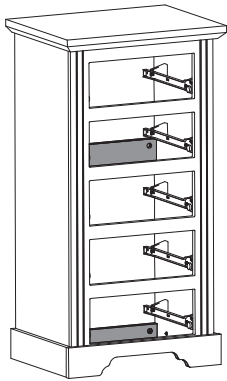

HARDWARE REQUIRED

TOOLS REQUIRED

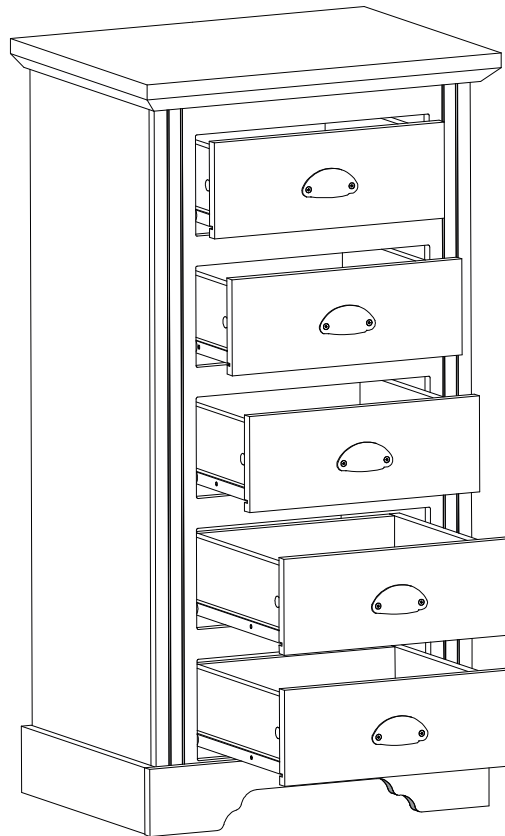

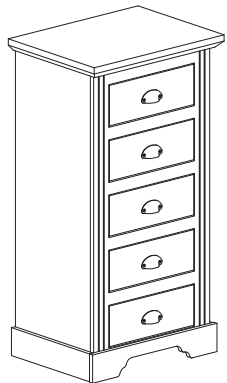

STEP 26

PARTS REQUIRED



HARDWARE REQUIRED

D		01
F		01
R		02

TOOLS REQUIRED

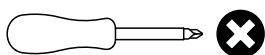

WARNING

Serious or fatal injuries can occur from furniture tipping over. To prevent the furniture from tipping over we recommend that it is permanently fixed to the wall.

Wall fixings are not supplied with this product as different wall materials require different types of fixing devices. Please make sure you use fixings suitable for the walls in your home.

